



**ILUKA**

**Iluka Resources (ASX:ILU)**

**Bank of America Global Metals and Mining Conference**

**16-18 May 2023**

This presentation has been prepared by Iluka Resources Limited (Iluka).

By accessing this presentation you acknowledge that you have read and understood the following statement.

This presentation includes forward-looking statements reflecting Iluka's current expectations. These statements are expressed in good faith and the expectations and beliefs are genuinely held but no representation or warranty is being made by Iluka that the matters stated in this presentation will in fact be achieved or prove to be correct. Readers should not place undue reliance on any forward-looking statement.

Forward-looking statements are subject to known and unknown risks, uncertainties and assumptions that could cause the actual results or achievements of Iluka to differ materially from expectations. These risks and uncertainties include changes in exchange rate assumptions; changes in labour or product pricing assumptions; major changes in mine plans and/or resources; changes in equipment life or capability; emergence of previously underestimated technical challenges; increased costs and demand for production inputs; physical events that materially impact project timelines or production schedules; and environmental or social factors which may affect a licence to operate, including political risk.

Iluka does not undertake to release publicly any revisions to any forward-looking statements to reflect events or circumstances after the date of this presentation, or to reflect the occurrence of unanticipated events, except as may be required under applicable securities laws.

All figures are expressed in Australian dollars unless stated otherwise.

## **Mineral Resources and Ore Reserve Estimates**

As an Australian company with securities listed on the Australian Securities Exchange (ASX), Iluka is subject to Australian disclosure requirements and standards, including the requirements of the Corporations Act and the ASX. Investors should note that it is a requirement of the ASX listing rules that the reporting of Ore Reserves and Mineral Resources in Australia comply with the 2012 edition of the Australasian Code for Reporting of Exploration Results, Mineral Resources and Ore Reserves (the "JORC Code") and that the Ore Reserve estimates and Mineral Resource estimates underpinning the Production Targets in this presentation have been prepared by a Competent Person in accordance with the JORC Code.

Information that relates to Mineral Resources estimates, Ore Reserve estimates, Production Targets and forecast financial information form part of Iluka's Annual reserves and resource Statement included in its 2022 Annual Report available at <https://iluka.com/investors-media/asx-releases>. The original market releases containing the Mineral Resources estimates, Ore Reserve estimates, Production Targets and forecast financial information, as well as statements and consents referred to in Listing Rule 5.22 are referred to on the slides where the relevant Mineral Resources estimates, Ore Reserve estimates, Production Targets and forecast financial information appear in this presentation.

Iluka confirms that it is not aware of any new information or data that materially affects the information included in the original market announcements and that all material assumptions and technical parameters underpinning the estimates, Production Targets and forecast financial information derived from Production Targets continue to apply and have not materially changed. Iluka confirms that the form and context in which the Competent Person's findings are presented have not been materially modified from the original market announcements.

## **Production outlook**

Production outlook and the basis thereof are noted within the relevant disclosure. The outlook included in this presentation is indicative only and should not be construed as guidance. The information is subject to changes in market and operating conditions; political risk; and any significant unplanned operational issues.

# A global critical minerals company

Iluka is the world’s largest producer of zircon; a major producer of high grade titanium feedstocks; and is set to become a significant global supplier of refined rare earths

Iluka’s production is located exclusively in Australia

## Critical minerals for everyday life

Zircon, titanium and rare earths are used in an array of everyday applications and are critical for sustainable development, including global electrification

## Operational experience

Over 70 years of critical minerals exploration, mining, processing, marketing and rehabilitation, with a pipeline of quality projects to meet growing demand

## ASX listed

Listed on the Australian Stock Exchange (ASX:ILU), market capitalisation of A\$4.7bn<sup>1</sup>

20% holding in Deterra Royalties (ASX:DRR), cornerstone asset of BHP Mining Area C iron ore royalty, market capitalisation of A\$2.4bn<sup>1</sup>

## Sustainable supply chain

A safe, responsible and sustainable supplier of critical minerals, supporting the transition to a modern, lower carbon economy

# Mineral sands and rare earths operations and projects in Australia

**Narngulu processing**



Processing: zircon, rutile, ilmenite

**Eneabba rare earths refining**



Refining: rare earths

**Cataby mine**



Mining: ilmenite, zircon, rutile, rare earths

**Capel processing**



Processing: synthetic rutile

**Iluka Projects**

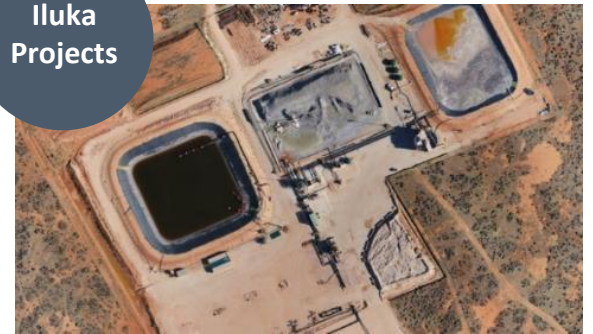

**1. Balranald**

rare earths, rutile, zircon, ilmenite

**2. Wimmera**

rare earths, zircon, ilmenite, rutile

**3. Euston**

rutile, rare earths, zircon, ilmenite

**4. Atacama**

zircon, ilmenite, rare earths, rutile

**Jacinth Ambrosia mine**



Mining: zircon, rutile, ilmenite, rare earths

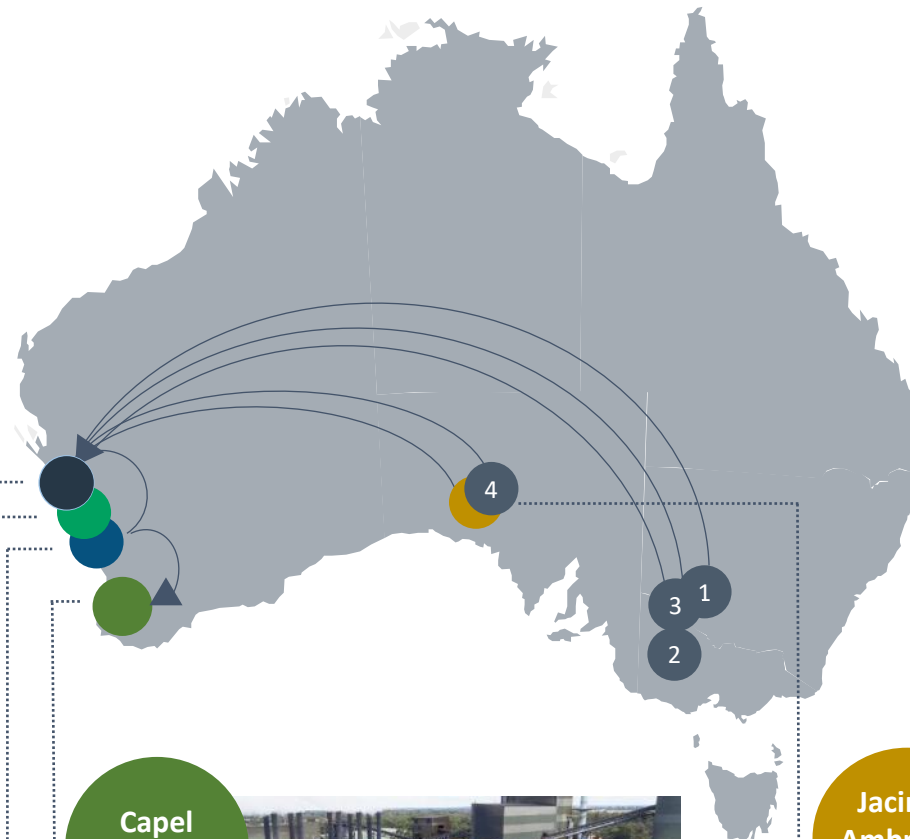

Note: Status of Iluka's projects: Balranald in execute; Wimmera in definitive feasibility study; Euston and Atacama in preliminary feasibility study.



## Financial

Record revenue of \$1,727 million

Sustainable zircon and rutile price growth

EBITDA margin increased to 53%

Resilient cash flow generation continued with \$444 million free cash flow

Net cash position of \$431 million (as at March 2023)

Fully franked dividend in line with framework



## Operational

Mines and processing facilities at maximum operational settings

SR1 kiln restarted

Key synthetic rutile offtake contracts agreed



## Strategic

Eneabba rare earths refinery approved

Balranald – completion of DFS to enable FID (taken February 2023)<sup>1</sup>

Wimmera – completion of PFS to enable move to DFS and Ore Reserve (declared February 2023)<sup>2</sup>

Strategic partnership with Northern Minerals agreed

Demerger of Sierra Rutile



## Sustainable

Western Australian Government Golden Gecko Award for Environmental Excellence winner

574 ha land rehabilitated

Employee diversity

- 24% women in total workforce
- 21% indigenous employment at Jacinth-Ambrosia

1. Refer Iluka ASX release *Balranald Development – Final Investment Decision*, 21 February 2023

2. Refer Iluka ASX release *Wimmera Ore Reserve and Mineral Resource Update*, 23 February 2023



ILUKA

# Mineral Sands



# A mature, cash generating business with a strong balance sheet

## Iluka sources and uses of cash flow Average 2018-2022

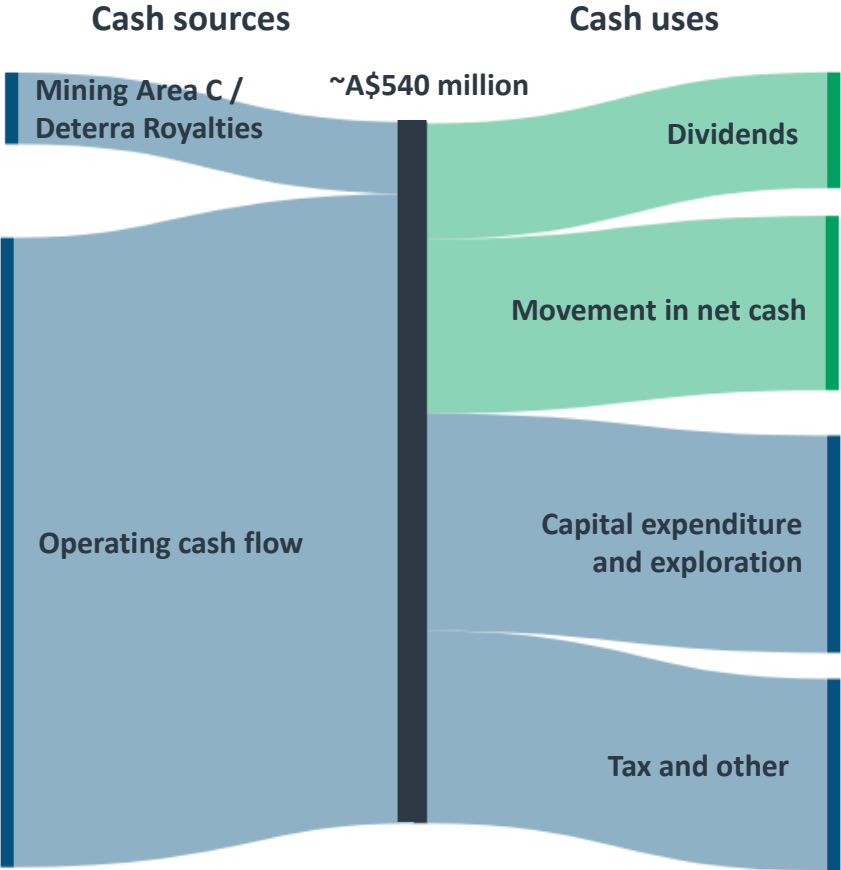

**1 Cash generating mineral sands business**  
Five year annual average operating cash flow: \$485 million

**2 Net cash position**  
\$431 million as at 31 March 2023

**3 Dividend framework delivering returns to shareholders**  
100% of dividends received from Deterra stake  
Mineral sands: minimum of 40% of free cash flow not required for investing or balance sheet purposes

**4 Future growth funded**  
Mineral sands: net cash balance, future cash generation, A\$570 million undrawn facilities  
Rare earths refinery: A\$1.25bn non-recourse loan from Australian Government

**5 Deterra stake**  
Iluka holds 20% stake in Deterra Royalties (ASX:DRR)  
Investment value of ~\$480 million<sup>1</sup>

1. As at 27 April 2023

*Iluka's portfolio of high grade, high quality critical minerals products produced in Australia delivers secure, reliable supply to customers globally*



## Zircon

2022 sales = 330kt<sup>1</sup>  
Market share = 29%

- Short and long term tightness of supply globally, inventories low
- Steady, sustainable price rises realised, including US\$50/tonne increase for Q2 2023

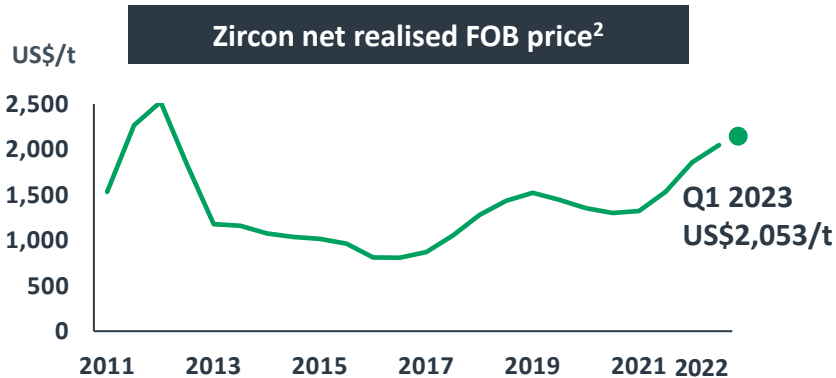

## Titanium - Synthetic Rutile

2022 sales = 246kt<sup>1</sup>  
Market Share = 28%

- ~200 ktpa synthetic rutile 'take or pay' offtake arrangements agreed for next four years with new and existing customers
- Disciplined downstream pigment industry shift to 'value over volume'
- High chlorine prices supporting demand for high grade titanium feedstock
- Iluka's rutile sales increasingly targeted to welding and metal markets, which achieve a price premium

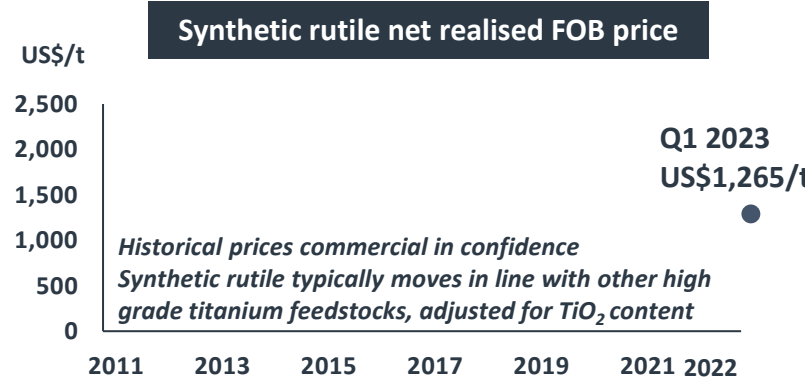

## Titanium - Rutile

2022 sales = 57kt<sup>1</sup>  
Market share = 7%

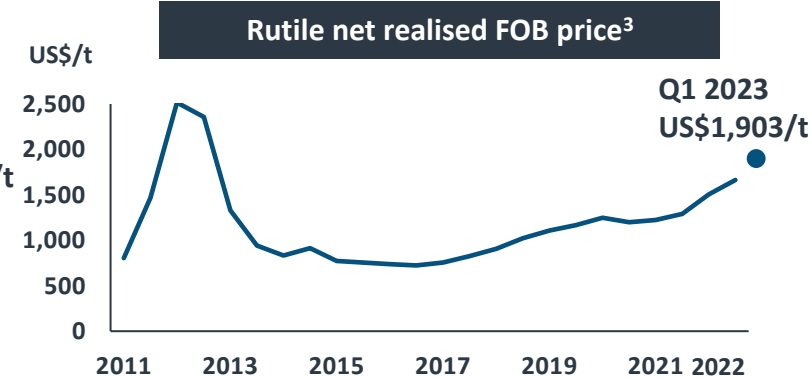

1. Excludes SRL sales volumes. 2. Zircon prices reflect the weighted average price for zircon premium and standard (excluding ZIC). 3. Rutile prices will vary quarter-on-quarter depending on end market to which product is supplied (e.g. pigment or welding) For market position detail, refer slides 25-27.



# Mineral sands production outlook

Group Z/R/SR production forecast to be maintained at ~600ktpa over next three years

Iluka has proven record of delivering projects to maintain supply

## Iluka group zircon, rutile, synthetic rutile production outlook<sup>1</sup>

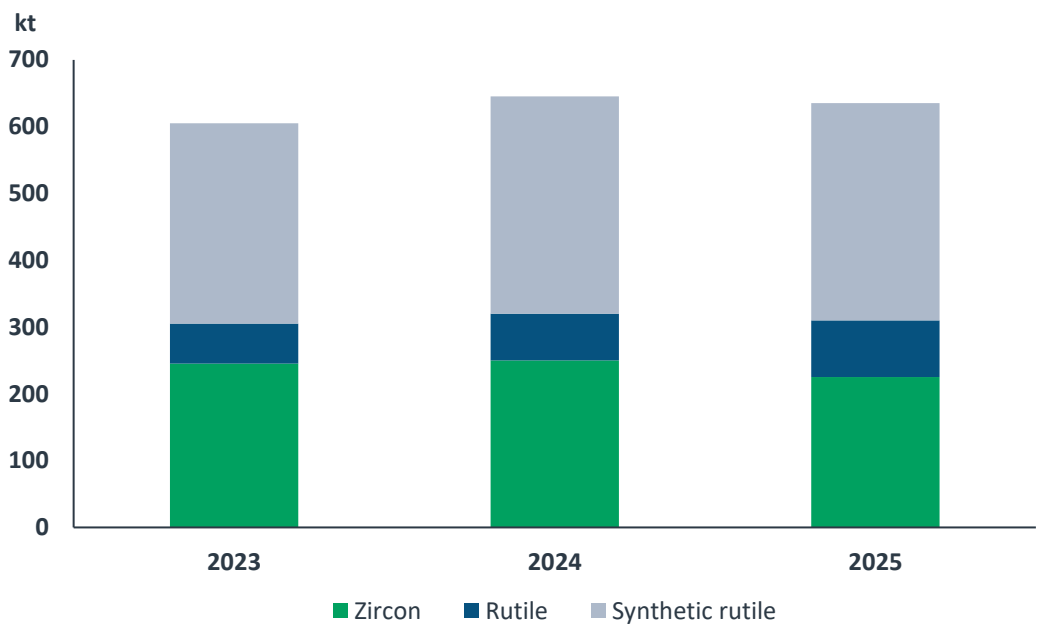

1. Includes existing operations (JA and Cataby) and approved new development (Balranald). Does not include other mineral sands development options (e.g. Wimmera, Atacama, Euston etc). Zircon is sand only and does not include zircon-in-concentrate (ZIC). For Balranald Production Target information refer to Iluka ASX release 'Balranald Development - Final Investment Decision', 21 February 2023.

### Zircon

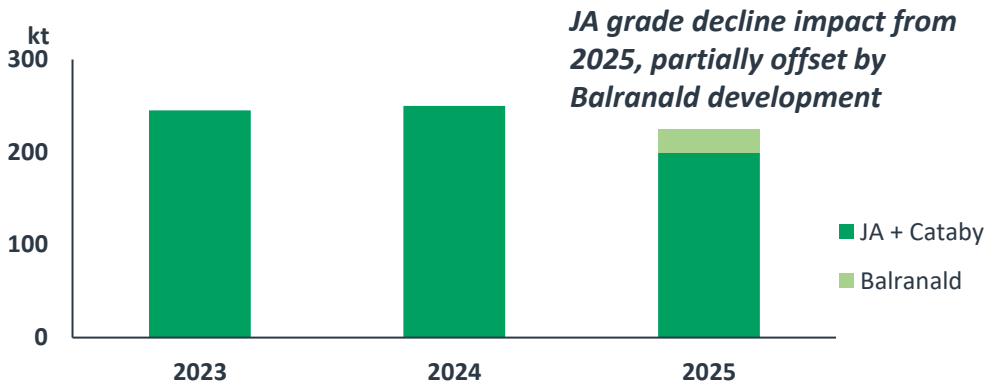

### Rutile

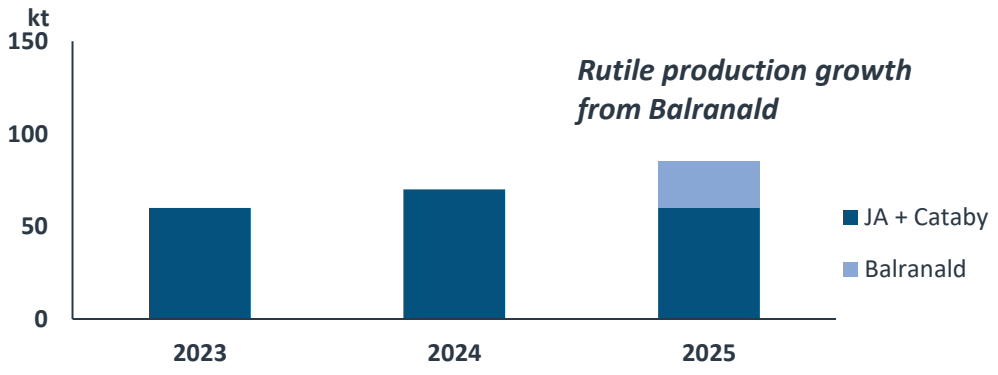

### Synthetic rutile

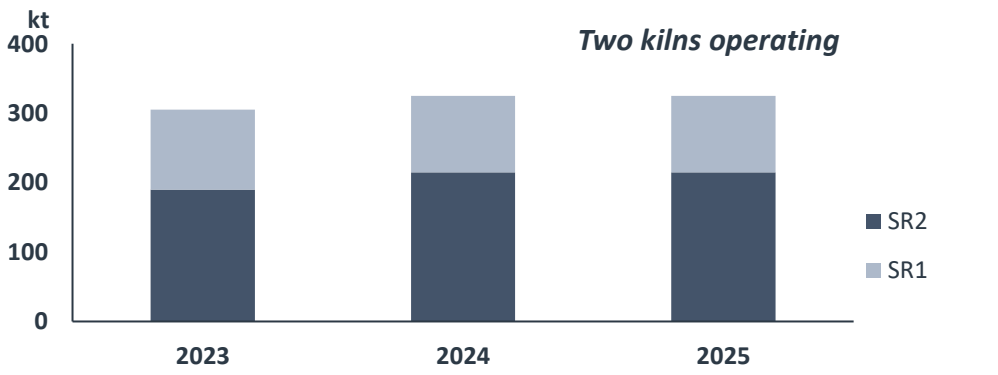

*Iluka's zircon-in-concentrate (ZIC) provides strategic flex supply to zircon market*

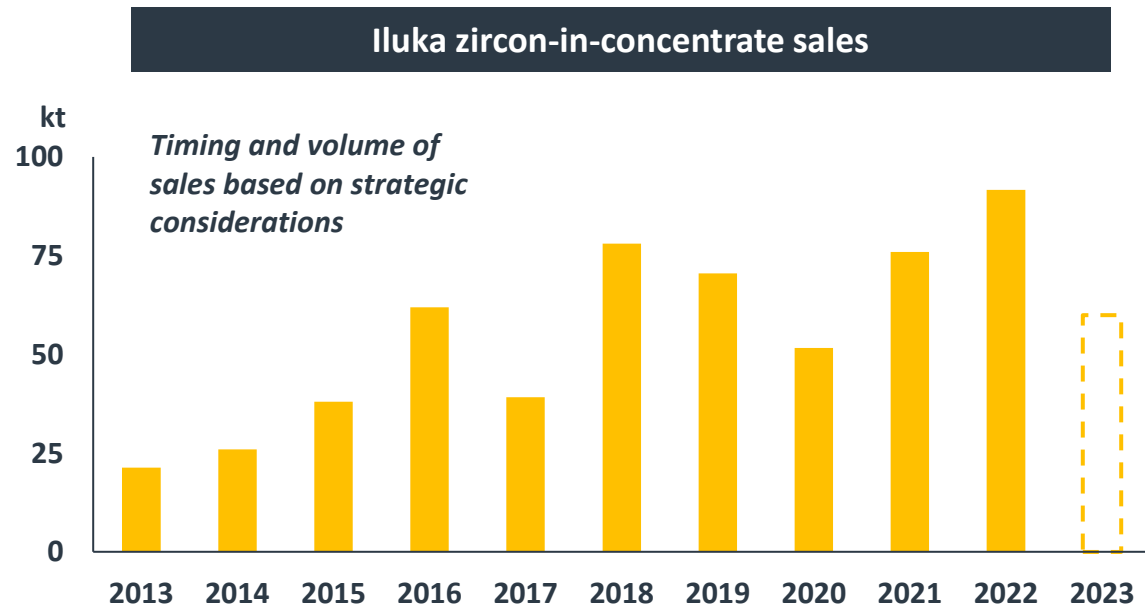

- ZIC is a lower grade zircon product
- Sold strategically as swing production into the market
- Price is at a discount to zircon sand but generates strong margin and monetises existing stockpiles of low value material
- Iluka guidance for 2023 is for 60kt ZIC sales
- Range of ongoing and future potential supply sources





ILUKA

# Rare Earths





**Integrated refinery producing separated light and heavy rare earth oxides at Eneabba, Western Australia**

**Funded via strategic risk sharing partnership with the Australian Government, including a \$1.25 billion non-recourse loan**

**Producing separated rare earth oxides essential for global electrification, including ~4ktpa Nd+Pr and up to 0.75ktpa Dy+Tb<sup>1</sup>**

*Demand for renewable energy technology demand to deliver the global electrification transition will require a significant increase in rare earth magnet oxides*

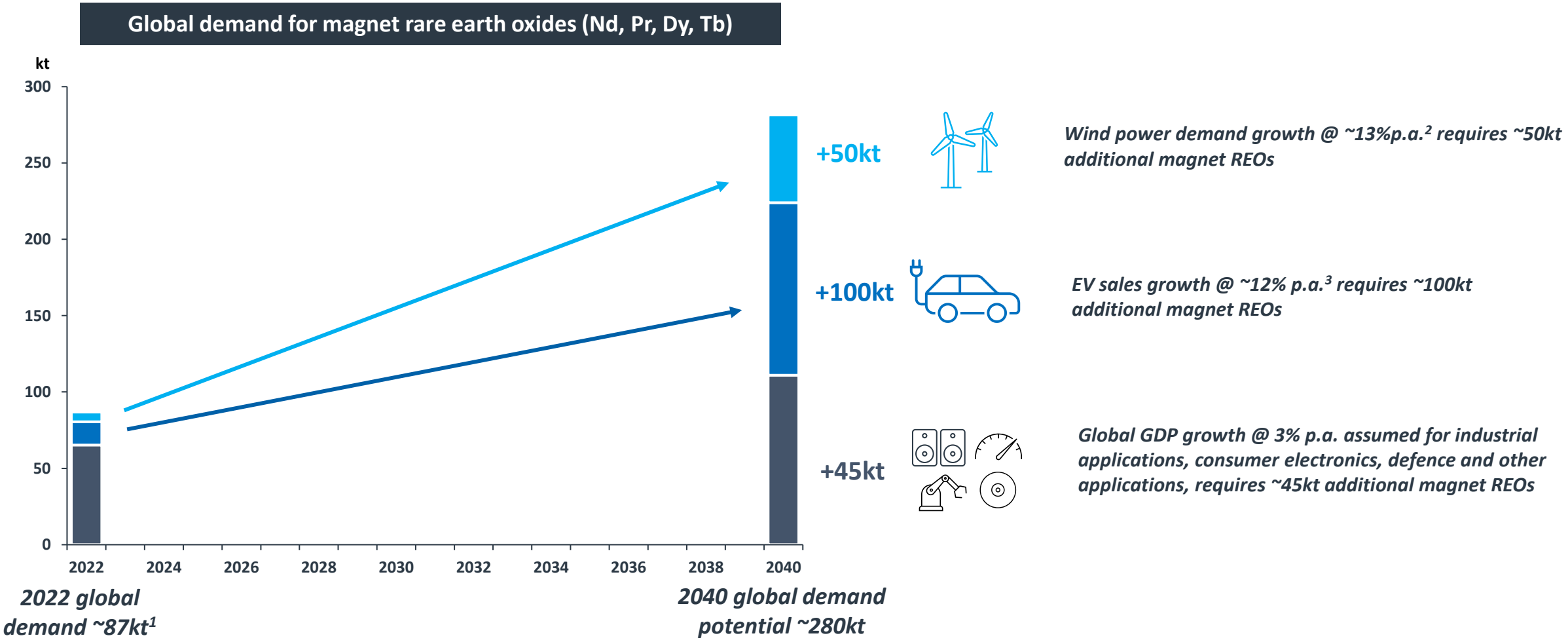

1. Source: Adamas Intelligence February 2022 2. Source: International Energy Agency (2021), Net Zero by 2050, IEA, Paris; International Energy Agency (2022) 3. Source: International Energy Agency, Annual electric car sales in the Sustainable Development Scenario, 2020-2040, IEA, Paris <https://www.iea.org/data-and-statistics/charts/annual-electric-car-sales-in-the-sustainable-development-scenario-2020-2040>, IEA. Licence: CC BY 4.0

Supply of magnet REOs from the Eneabba refinery will form an important part of Western and likeminded supply chains for global electrification

## Global supply and demand for magnet rare earth oxides (Nd, Pr, Dy, Tb)

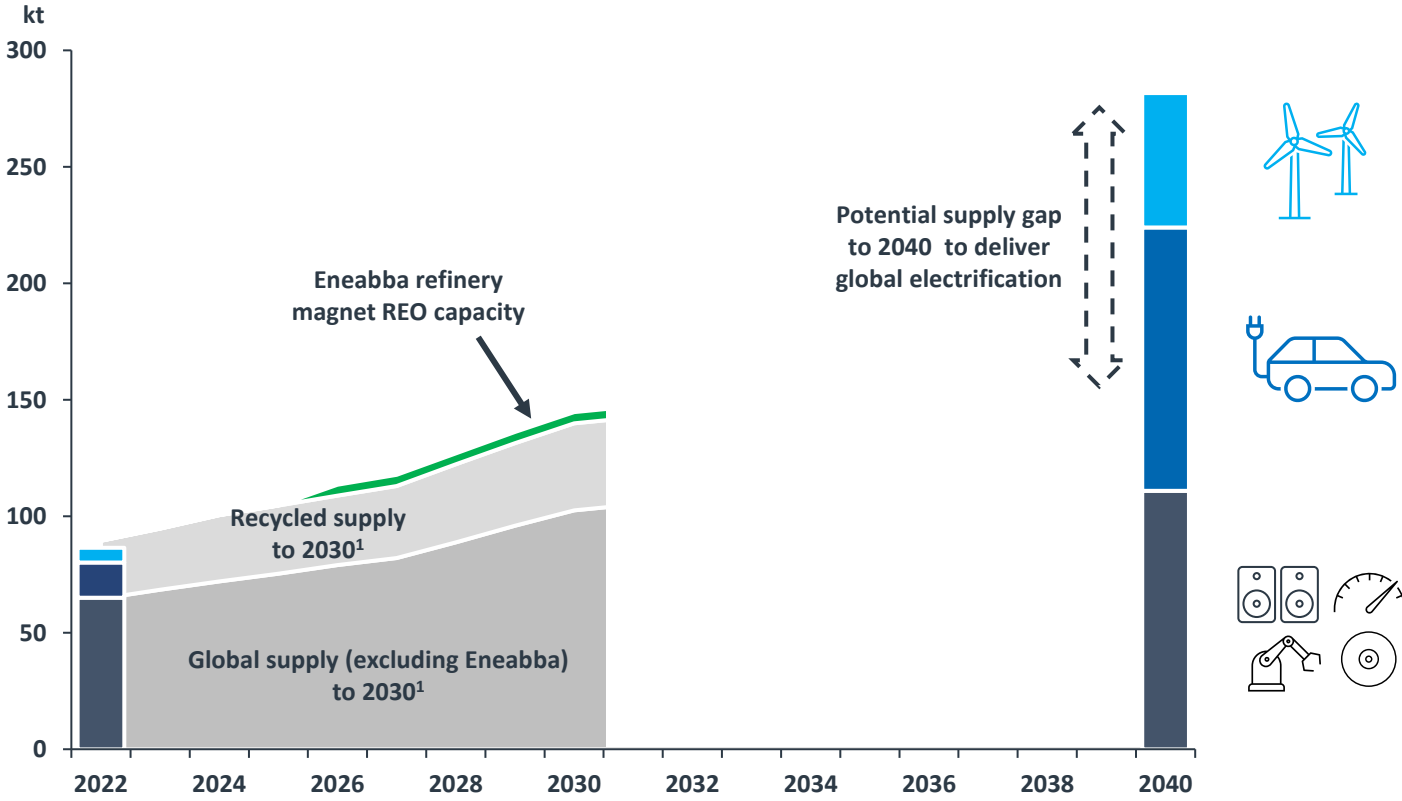

## NdPr oxide 2022 global supply<sup>1</sup> Total = 62.3kt

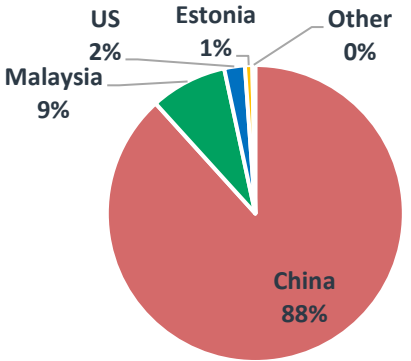

## Dy, Tb oxide 2022 global supply<sup>1</sup> Total = 2.3kt

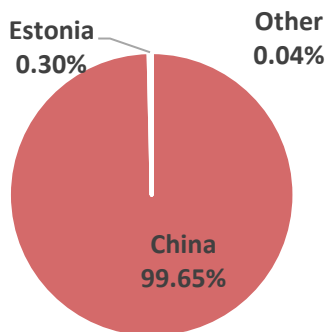

1. Source: Adamas Intelligence February 2022

  
 EV motor contains ~1.5kg of NdFeB magnets (or ~0.5kg NdPr oxide)  
 Magnets also in other EV componentry (sensors, small motors, etc)

  
 Typical EV/HEV motor operates at over 180°C

  
 Magnet performance declines as temperature increases

  
 Dy, Tb required in NdFeB magnets to operate at temperatures >100°C

## Magnet applications, operating temperature and heavy rare earth content<sup>1</sup>

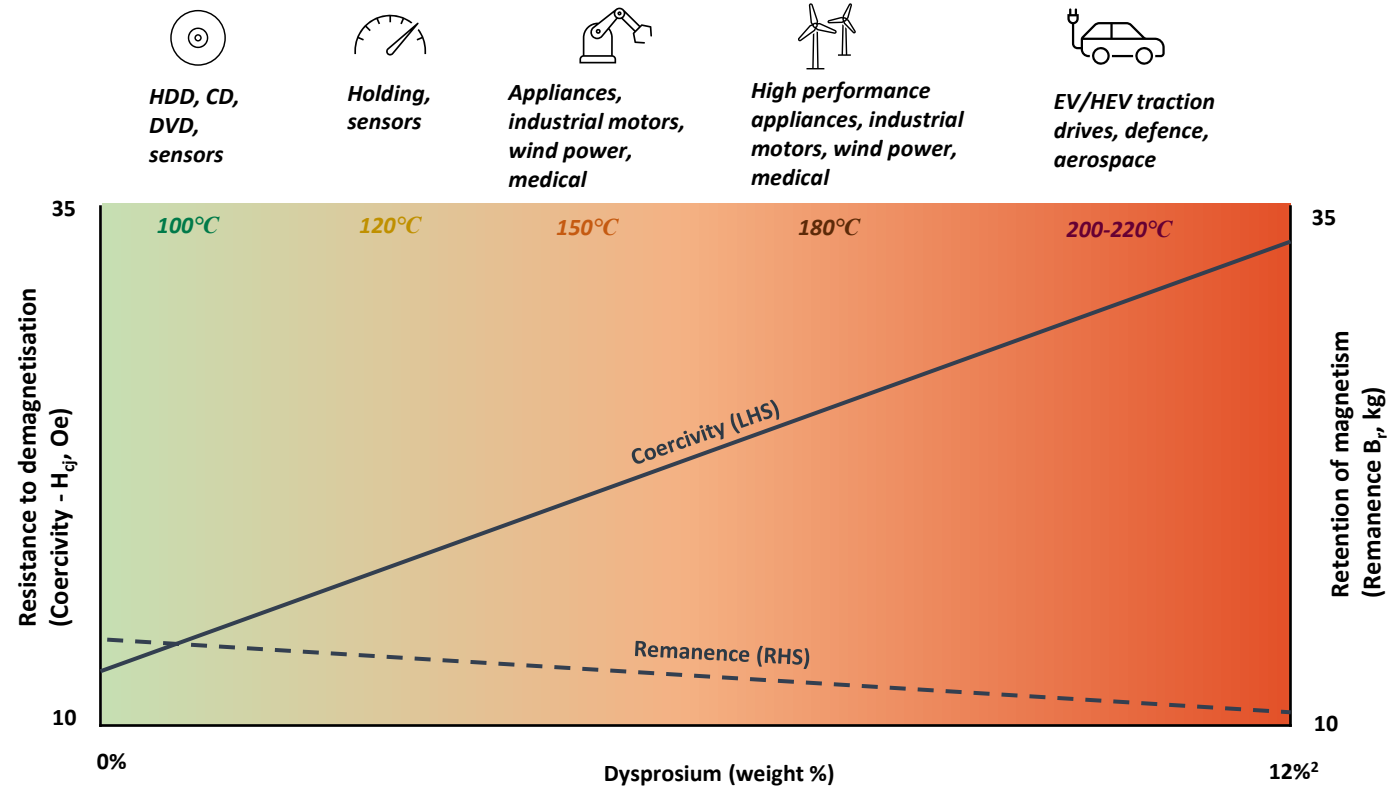

**Key terminology**  
 Coercivity = Ability of a magnet to withstand an external magnetic field without becoming demagnetized, ie. susceptibility for demagnetisation  
 Remanence = The ability of a material to retain magnetisation after magnetic field applied, ie. magnetic memory

1. Source: Advances in Processing, Manufacturing, and Applications of Magnetic Materials, *Manufacturing Processes for Permanent Magnets: Part I—Sintering and Casting*, Cui, Ormerod, Parker, Ott, Palasyuk, McCall, Paranthaman, Kesler, McGuire, Nlebedim, Pan, and Lograsso, licence: <http://creativecommons.org/licenses/by/4.0/>  
 2. Indicative based on estimates in article referenced above. Individual magnet Dy content will vary within applications and across manufacturers.

## Eneabba stockpile

~1 million tonnes of high grade rare earth concentrate, readily available at surface  
 Refinery could be filled for ~5 years with stockpile alone<sup>1</sup>

## Internal Iluka options

Balranald – in execute  
 Wimmera – definitive feasibility study underway

## Third party agreements

Northern Minerals strategic partnership agreed<sup>2</sup>  
 Other discussions ongoing

Magnet REO contribution to REO basket value @ 2022 prices

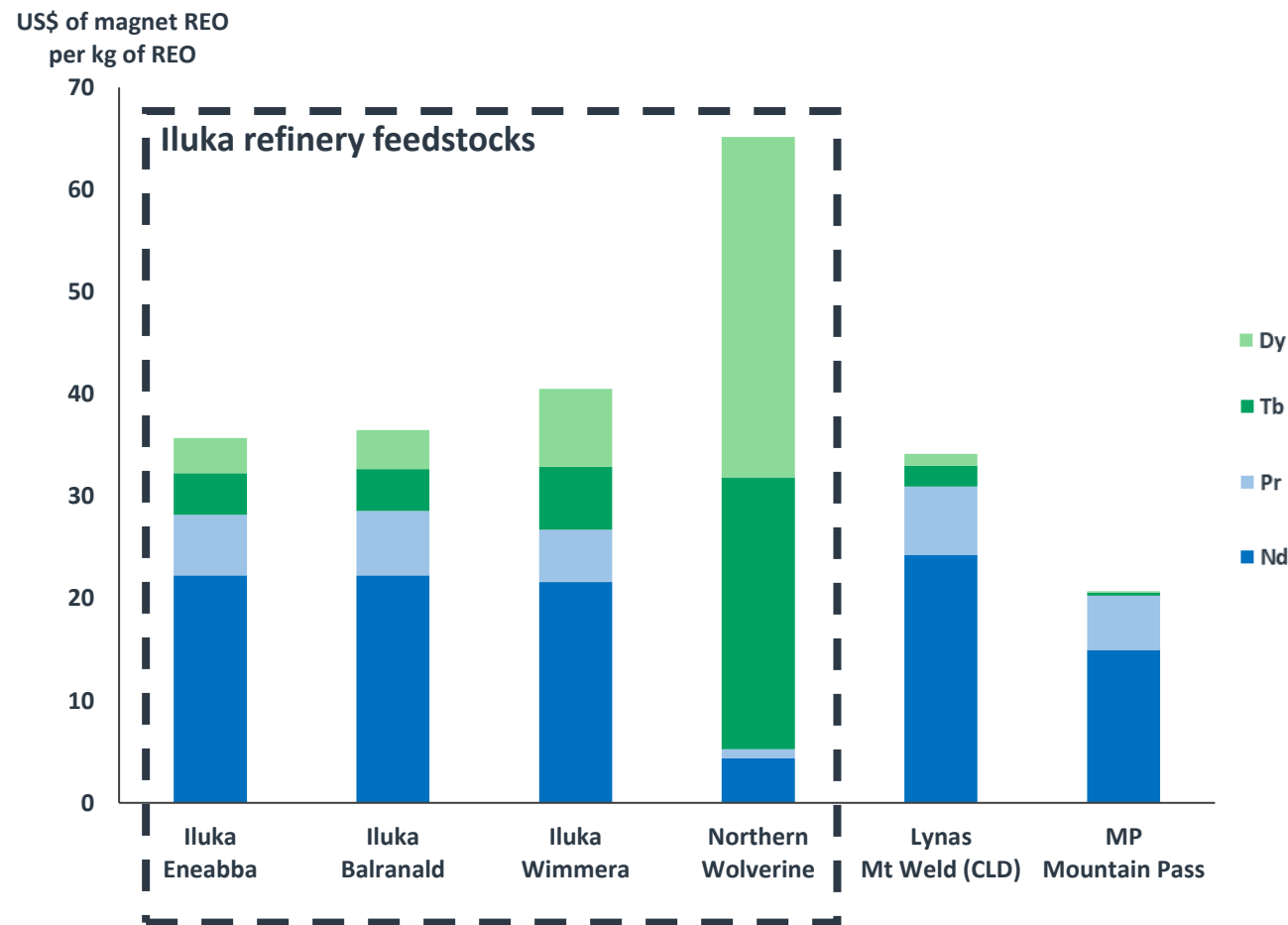

Source: Iluka, Adamas Intelligence, Resource Geology and company reports

1: Mineral Resource and Ore Reserve detail provided on slide 29. Further detail in Iluka ASX release, 'Eneabba Rare Earths Refinery Final Investment Decision Presentation', 4 April 2022.

2: Under Iluka's strategic partnership with Northern Minerals, Iluka will purchase concentrate from Northern's Browns Range project as an additional source of feedstock to the Eneabba rare earths refinery. Rare earth oxides will be marketed and sold by Iluka.





ILUKA

# Growth

- ★ Executed
- ★ Future events



**1 EXECUTE**  
*Project execution*

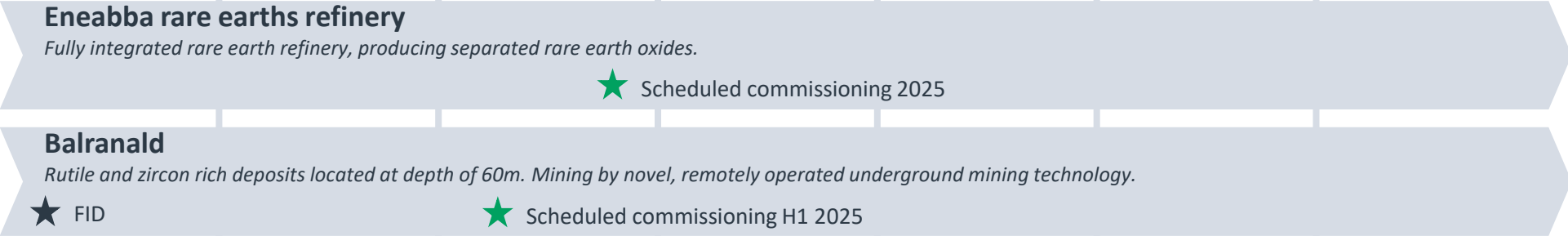

**2 DEVELOP**  
*Definitive Feasibility Study*

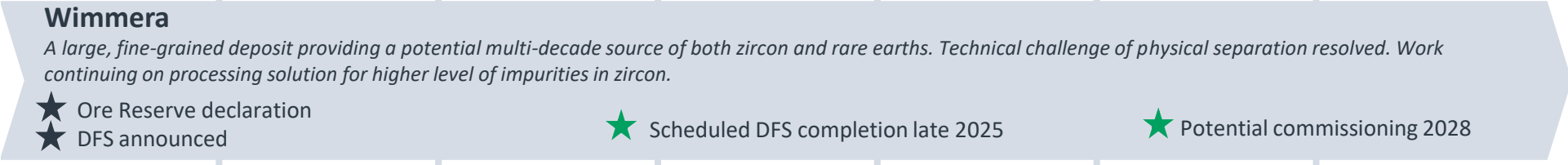

**3 SELECT**  
*Preliminary Feasibility Study*

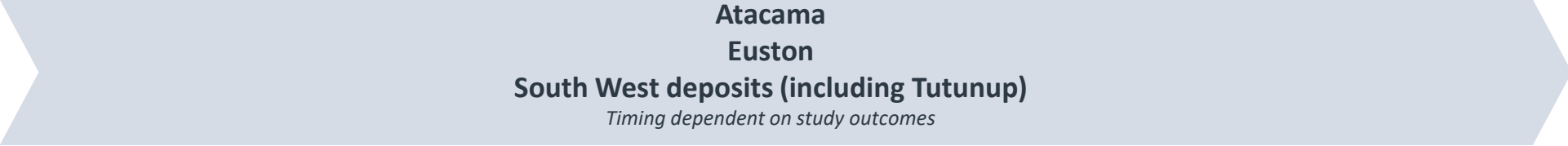

**4 SCOPING**  
*Opportunity identification and options analysis*

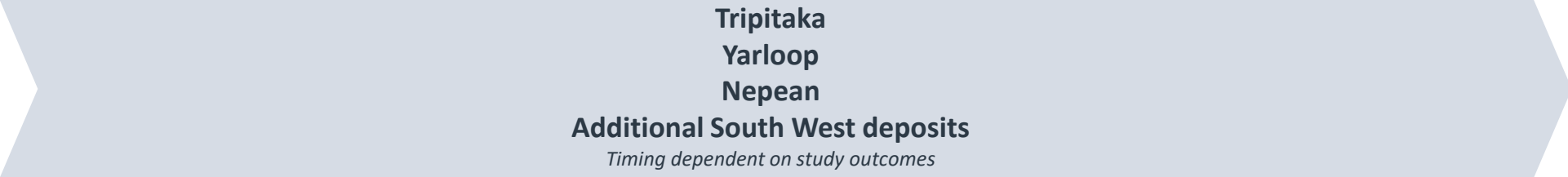

# Iluka's future potential revenue mix

Historically, Iluka's revenue has been derived primarily from its mineral sands business

The company's future potential revenue mix is strongly weighted to rare earths

<b>1</b> Balranald rutile-zircon mine commissioned	<b>2</b> Eneabba rare earth refinery commissioned	<b>3</b> Northern Minerals potential production of feedstock for Eneabba	<b>4</b> Potential Wimmera final investment decision
---	---	---	---

Potential revenue split<sup>1</sup>

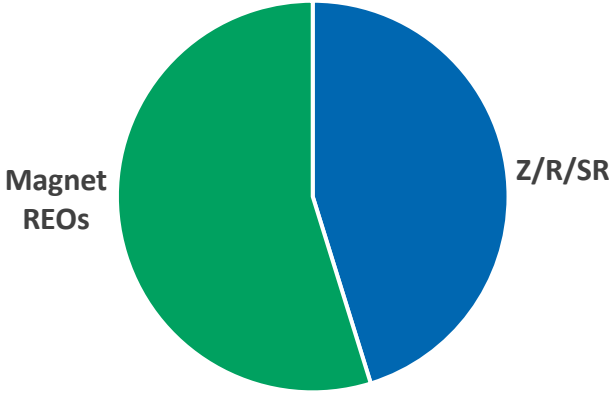

Refinery magnet REO production  
~4ktpa NdPr + 0.75kt Dy, Tb  
@ 2022 prices<sup>2, 3</sup>

1. Potential revenue split based on 2022 Z/R/SR production of 211/55/238kt respectively (excludes ZIC and SRL); assumes refinery operational for the same period; and excludes Deterra dividend receipts.  
2. Iluka 2022 Z/R/SR weighted average received prices; Adamas 2022 REO prices, refer slide 24.  
3. Refer to Iluka ASX release 'Eneabba Rare Earths Refinery Final Investment Decision Presentation', 4 April 2022.



ILUKA

# Supplementary Information

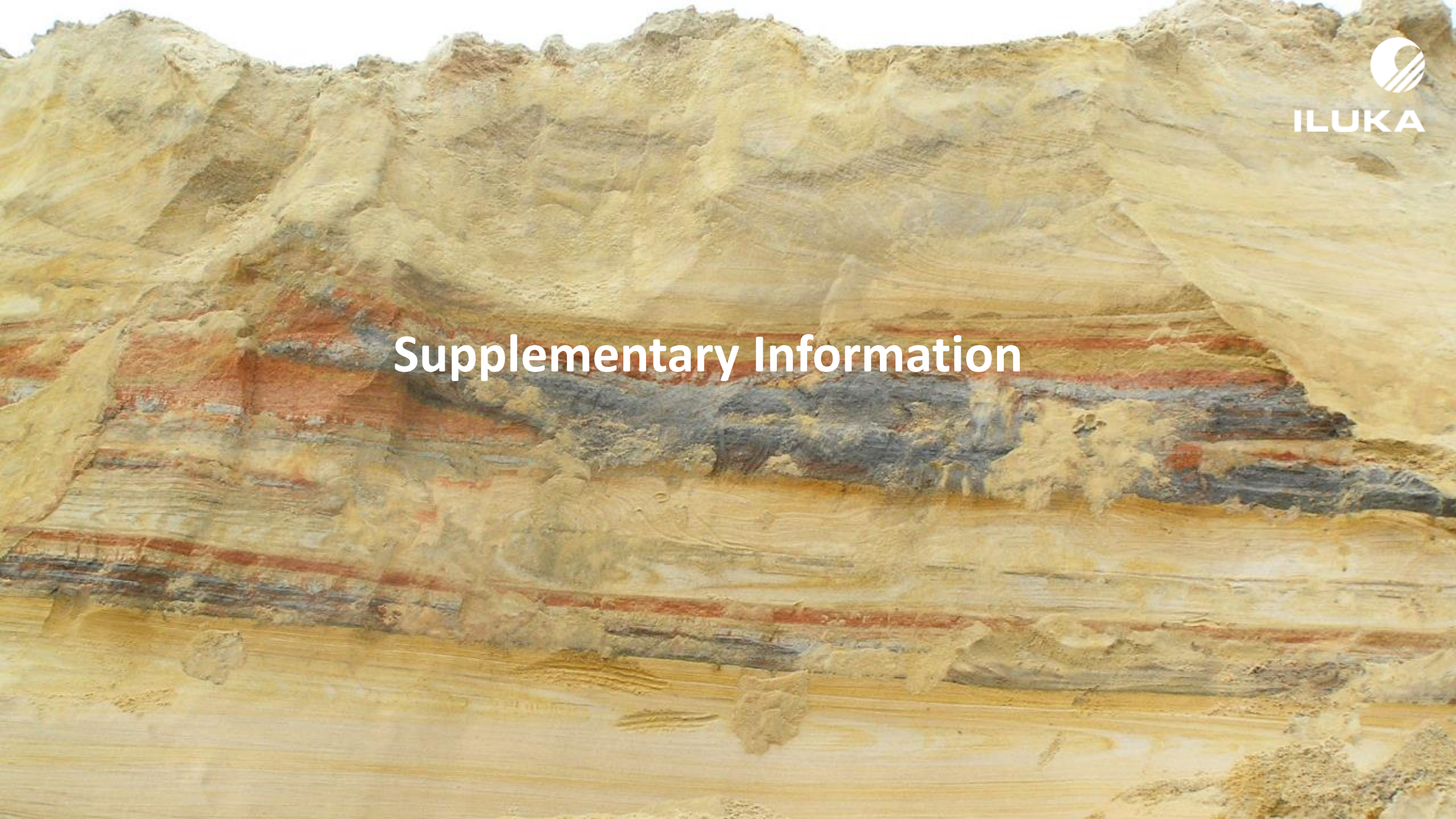

*Iluka's valuable Deterra Royalties stake provides increased long term financial strength*

*Iluka's dividend framework is to distribute 100% of all cash received from Deterra*



**Iluka owns 20% of ASX-listed Deterra Royalties (ASX:DRR)**

*Cornerstone asset: Mining Area C (MAC) iron ore royalty*

*Market cap: \$2.4 billion<sup>3</sup>*





### Deterra's Mining Area C Royalty

*Royalty terms: Payment of 1.232% of Australian dollar denominated revenue from MAC royalty area; and one off A\$1 million capacity payment per 1 million tonne increase in annual MAC production.*

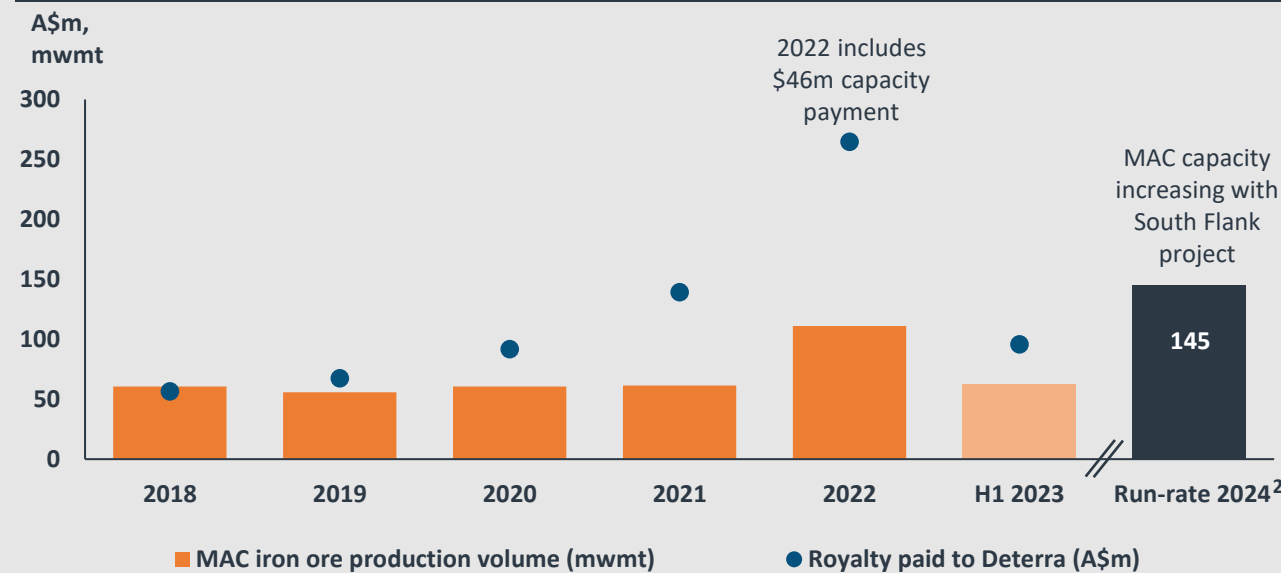
### MAC production volumes and royalty<sup>1</sup>



1. Deterra H1 FY 2023 Results Presentation. Financial Year relates to Deterra 30 June year-end. 2. BHP South Flank presentation, 4 October 2022 available at [www.bhp.com](http://www.bhp.com) 3. As at 27 April 2023.

Mineral sands	Deterra Royalties stake	Rare earths
<b>Debt Framework</b> No net debt through the investment cycle		
 <p>Strong cash flow generation – average operating cash flow over five years of \$485 million</p> <p>Undrawn Multi Option Facility Agreement (MOFA) facilities \$570 million, maturing December 2027</p> <p>Dividends – minimum of 40% of free cash flow not required for investing or balance sheet purposes</p>	 <p>Deterra royalty stream benefiting from production growth at BHP’s Mining Area C South Flank<sup>1</sup></p> <p>100% of dividends received from Iluka’s 20% stake in Deterra Royalties paid to Iluka shareholders</p>	 <p>Eneabba refinery funded in partnership with Australian Government via \$1.25 billion Critical Minerals Facility loan</p> <p>Rare earths diversification does not put mineral sands business at risk</p>

1. Subject to iron ore prices and AUD:USD exchange rate.



- Blend of feed concentrate based on feed availability
- Only selected circuits most relevant for modelling purposes shown
- SX circuit capacities are applied with an average recovery assumption of 90% across refinery
- For modelling purposes, using the constraints shown, the first constraint reached determines feed rate

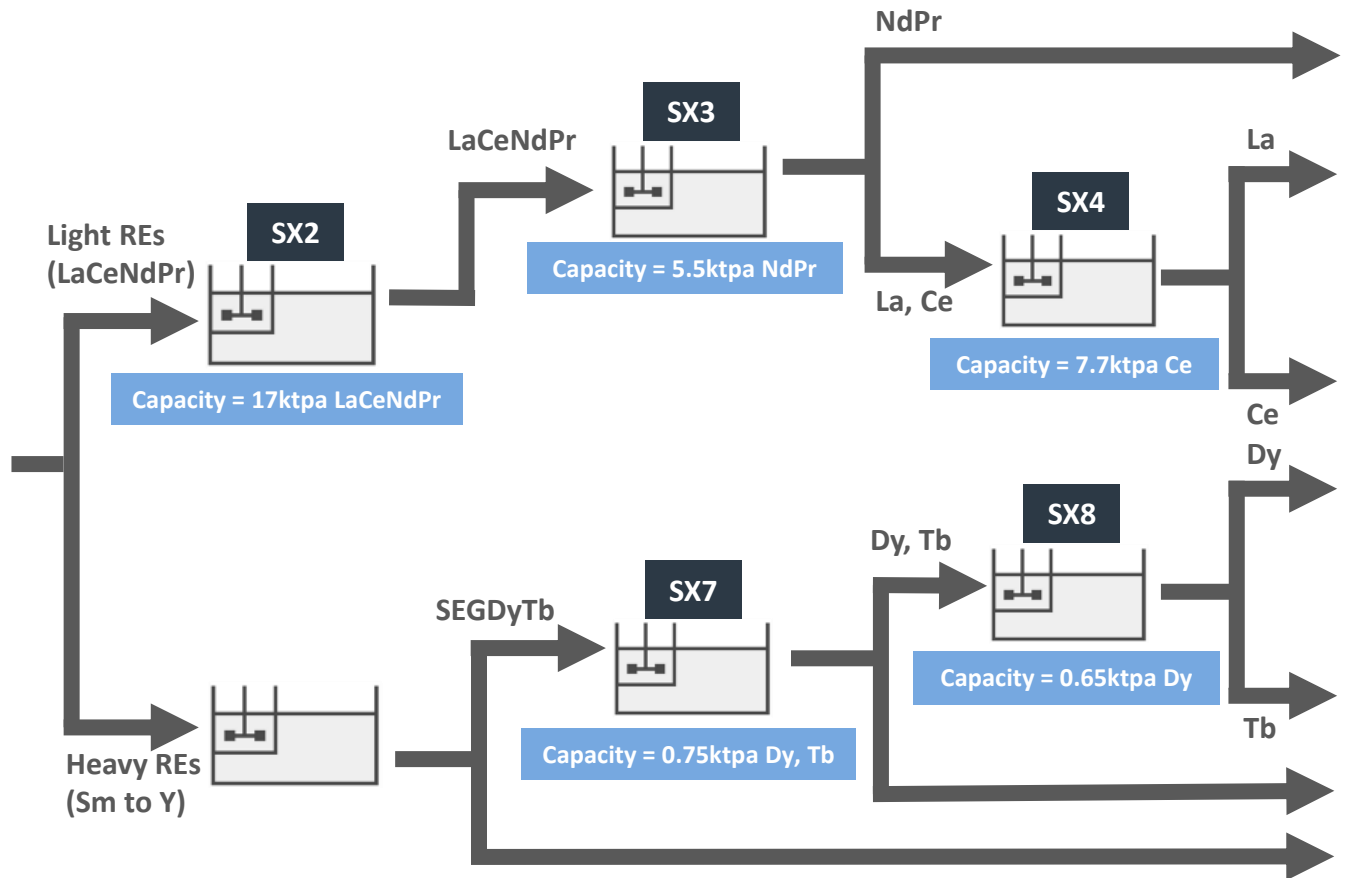
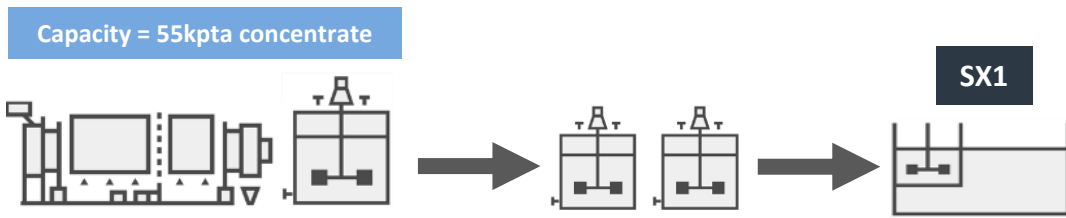

**Worked example – Eneabba stockpile feed only**

- Assume 32kt concentrate feed @ ~57%<sup>1</sup> REO grade @ 90%<sup>2</sup> recovery = 16kt REO
- Eneabba REO assemblage: La=21.8%, Ce=45.0%, Nd=16.6%, Pr=4.6%, Tb=0.2%, Dy=0.9%
- ✓ SX2 capacity check: LaCeNdPr = 14.5kt
- ✓ SX3 capacity check: NdPr = 3.5kt
- ✓ SX4 capacity check: Ce = 7.4kt (SX4 is the production constraint in this example)
- ✓ SX7 capacity check: Dy, Tb = 0.2kt<sup>3</sup>
- ✓ SX8 capacity check: Dy = 0.15kt<sup>3</sup>

1. Indicative only – Feed may be higher or lower grade. 2. Simplified weighted average recovery assumption across all circuits 3. Northern Minerals feed rich in Dy and Tb could see this capacity reached with relatively small increase to concentrate fed into refinery.

## Magnet REO contribution to basket value @ 2022 prices

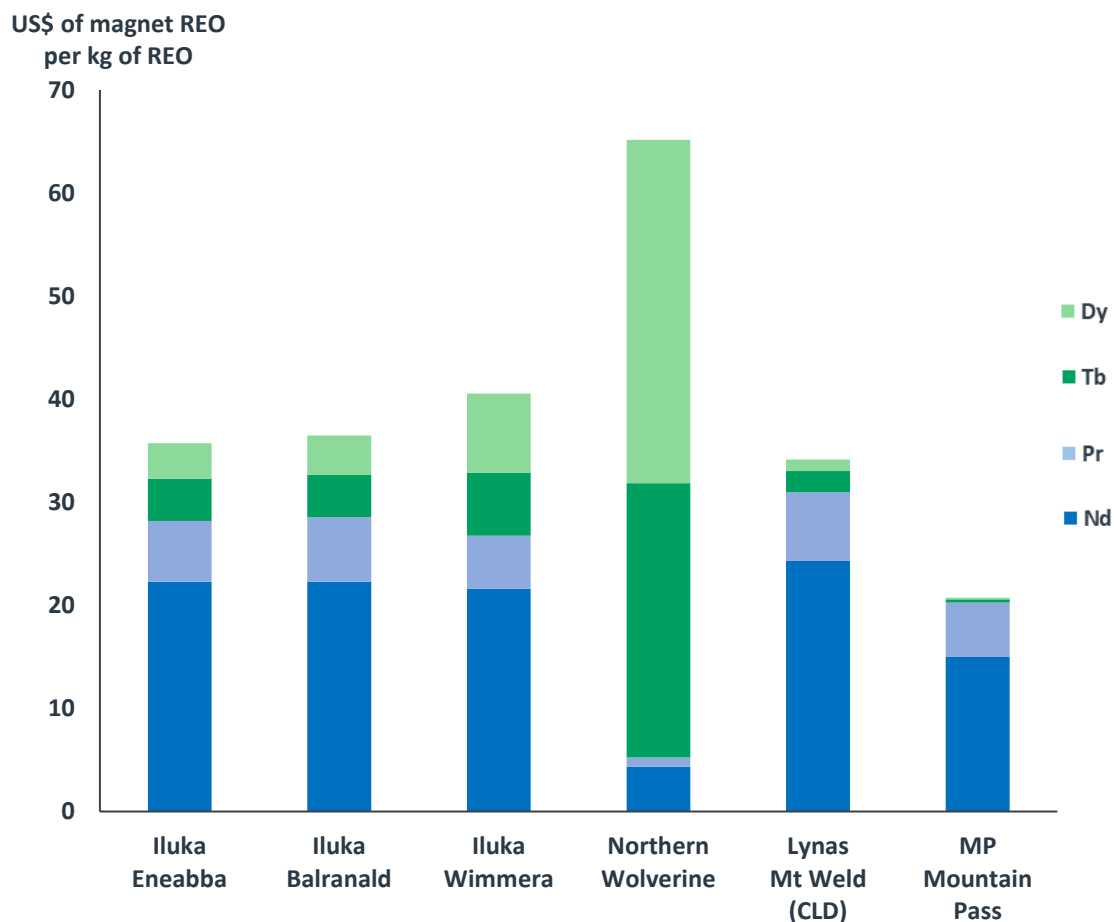

## REO assemblages and prices

REO	Iluka Eneabba <sup>1</sup>	Iluka Wimmera WIM100 <sup>1</sup>	Iluka Balranald <sup>1</sup>	Northern Browns Range Wolverine <sup>2</sup>	Lynas Mt Weld	MP Materials Mountain Pass	2022 prices US\$/kg (Adamas)
La	21.8%	17.7%	20.8%	2.0%	24.3%	33.8%	1
Ce	45.0%	37.4%	45.5%	5.0%	44.5%	49.6%	1
Pr	4.6%	4.0%	4.9%	0.7%	5.0%	4.1%	128
Nd	16.6%	16.1%	16.6%	3.2%	18.0%	11.2%	134
Sm	2.5%	2.7%	3.0%	2.2%	2.6%	0.9%	4
Eu	0.1%	0.1%	0.0%	0.5%	0.6%	0.1%	30
Gd	1.4%	2.3%	2.0%	5.8%	1.4%	0.2%	69
Tb	0.2%	0.3%	0.2%	1.3%	0.2%	0.0%	2,046
Dy	0.9%	2.0%	1.0%	8.7%	0.6%	0.0%	382
Ho	0.2%	0.4%	0.1%	1.8%	0.1%	0.0%	179
Er	0.5%	1.2%	0.4%	5.2%	0.2%	0.0%	54
Tm	0.1%	0.2%	0.1%	0.7%	0.0%	0.0%	-
Yb	0.4%	1.1%	0.3%	4.1%	0.1%	0.0%	17
Lu	0.1%	0.1%	0.0%	0.6%	0.0%	0.0%	810
Y	5.6%	14.2%	5.0%	58.3%	2.4%	0.1%	12

Source: Iluka, Adamas Intelligence, Resource Geology and company reports

1. Measured REO distribution in concentrate recovered. 2. Under Iluka's strategic partnership with Northern Minerals, Iluka will purchase concentrate from Northern's Browns Range project as an additional source of feedstock to the Eneabba rare earths refinery. Rare earth oxides will be marketed and sold by Iluka.



*Iluka is a leading global producer of zircon and high grade titanium feedstocks; the company's rare earths diversification is expected to make a meaningful contribution to the sustainable supply of rare earths, with commissioning scheduled for 2025*

## High grade titanium

(Iluka products: rutile and synthetic rutile)



**2022 global high grade titanium supply<sup>1</sup>**  
(total market = 3.2mt TiO<sub>2</sub>)

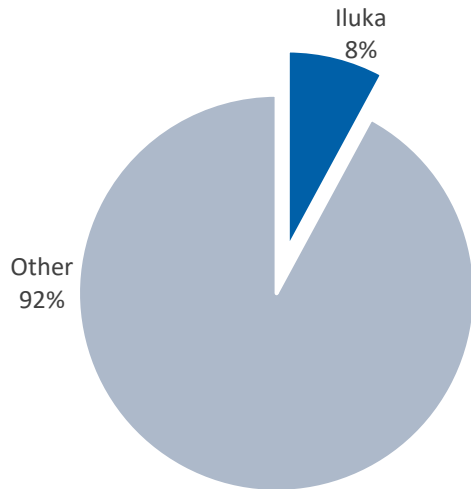

1. Includes rutile, synthetic rutile, chloride slag and UGS.  
Source: Iluka and TZMI

## Zircon



**2022 global zircon supply**  
(total market = 1.2mt)

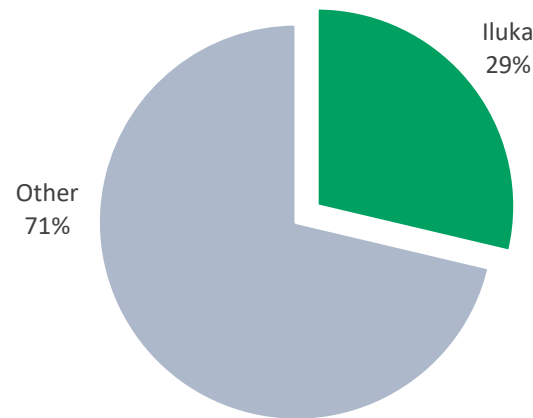

Source: Iluka and TZMI

## Magnet rare earths

(Iluka future production: includes high value neodymium, praseodymium, dysprosium, terbium)

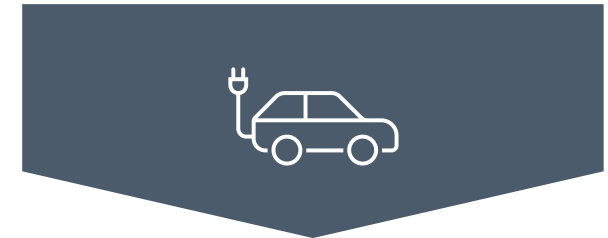

**2022 global magnet REO supply pro-forma to include Eneabba refinery<sup>2</sup>**  
(total market = 94kt)

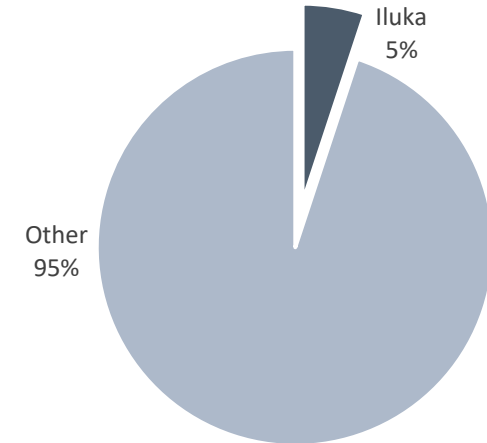

2. Iluka share indicative based on supply from Eneabba refinery of 4kt NdPr, 0.75kt Dy,Tb  
Source: Iluka and Adamas

## High grade titanium



## Zircon



**2022 global synthetic rutile supply (775kt TiO<sub>2</sub>)**

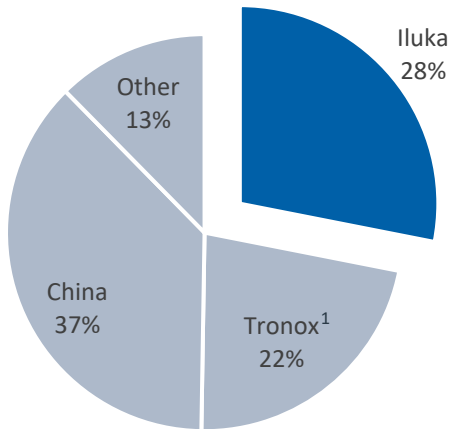

**2022 global rutile supply (485kt TiO<sub>2</sub>)**

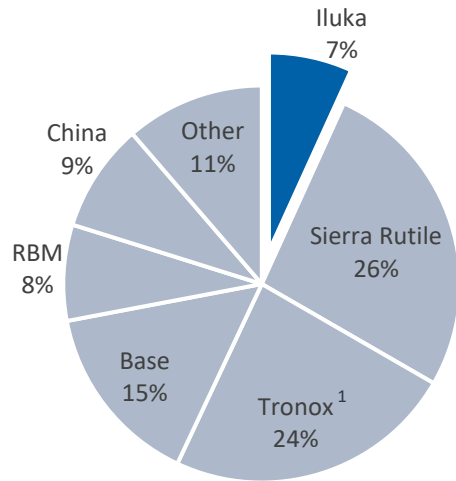

**2022 global chloride slag supply (1,700kt TiO<sub>2</sub>)**

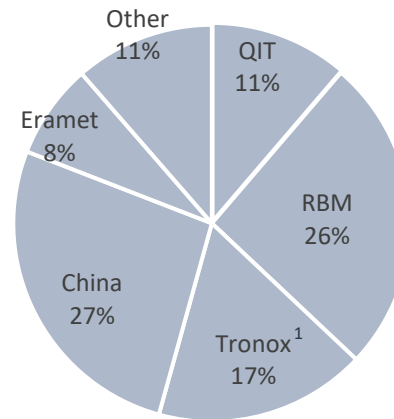

**2022 global zircon supply (1,200kt)**

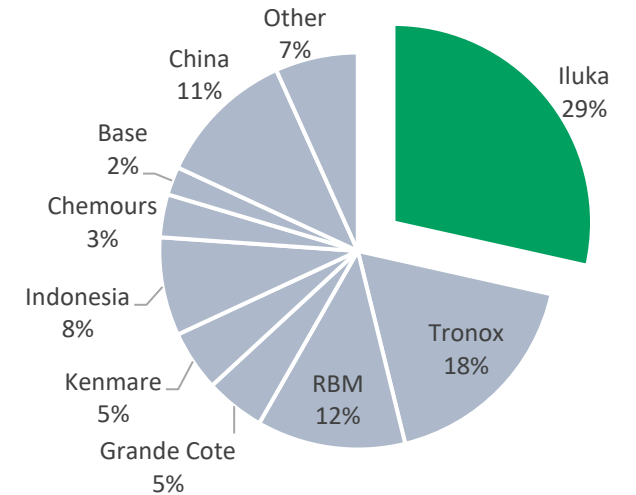

**2022 UGS global supply (235kt TiO<sub>2</sub>)**  
100% QIT

1. Tronox is a vertically integrated mining and inorganic chemicals business.  
Source: Iluka and TZMI

## Titanium feedstocks

(Iluka products: rutile, synthetic rutile and ilmenite)



*Industry demand*

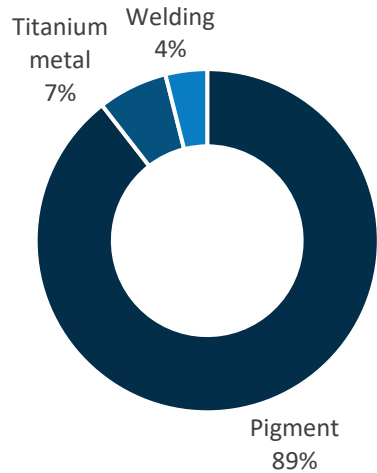

*Iluka sales<sup>1</sup>*

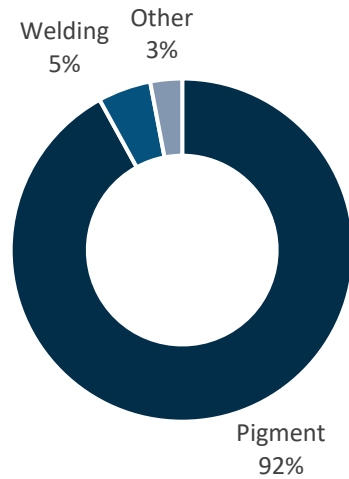

1. Excludes SRL  
Source: Iluka and TZMI

## Zircon



*Industry demand*

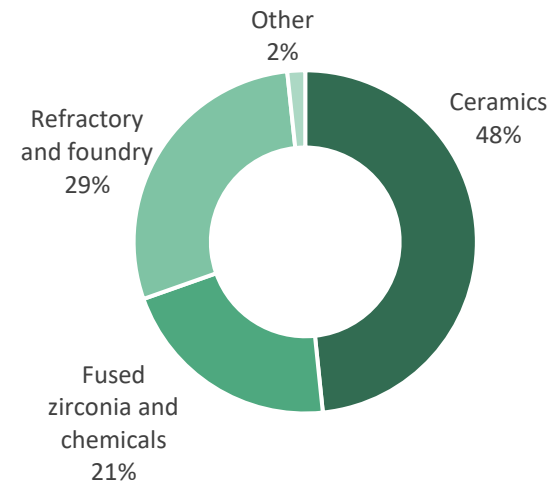

*Iluka sales<sup>1</sup>*

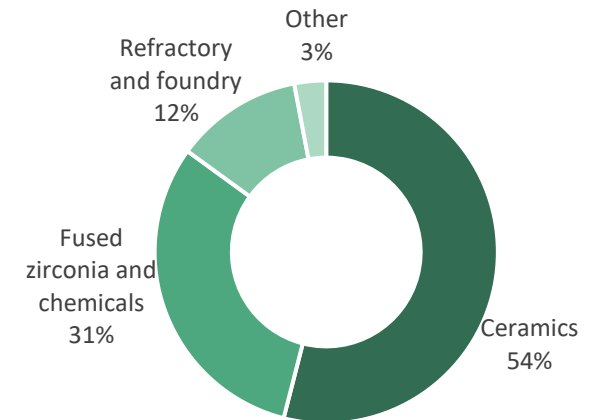

*Through strategic partnerships and collaboration, Iluka has de-risked its rare earths diversification financially and technically; and enhanced its future product offering for valuable heavy rare earths*



**Australian Government**

- Risk sharing partnership includes A\$1.25 billion non-recourse loan
- Loan includes features to support resilience of Eneabba refinery in the face of potential technical, operating and/or market challenges



- Preeminent source of Western expertise for rare earths refining (based in France)
- Embedded within Iluka's owner's team for Eneabba project since 2020
- Knowledge and technology transfer agreement to build Iluka's capability



- Strategic partnership for supply of rare earths concentrate agreed October 2022
- Provides attractive opportunity to secure an additional source of quality feedstock
- Northern's deposit is uncommon globally, with a high assemblage of valuable heavy rare earths, dysprosium and terbium
- Most of the world's supply of dysprosium and terbium is currently derived from ionic clay deposits in China and Myanmar

**Rare earths are among the key building blocks of an electrified, low carbon global economy**

For further information, refer to Iluka ASX release *Eneabba Rare Earths Refinery Final Investment Decision Presentation*, 4 April 2022 and Iluka ASX release *Strategic Partnership with Northern Minerals Rare Earths Concentrate Supply*, 26 October 2022.

Deposit	Mineral Resource Category <sup>(1)</sup>	Material Tonnes mt	In Situ HM Tonnes kt	HM Grade (%)	Clay Grade (%)	HM Assemblage <sup>(2)</sup>			
						Ilmenite Grade (%)	Zircon Grade (%)	Rutile Grade (%)	M+X Grade (%)
MSP By-Product Stockpile	Measured	0.68	0.57	84.0	3	32	26	-	21.4
	Indicated	0.29	0.24	82.5	3	37	31	-	13.2
	Inferred	0.06	0.04	69.4	5	38	29	-	13.2
<b>Total<sup>(4)</sup></b>		<b>1.0</b>	<b>0.85</b>	<b>82.9</b>	<b>3</b>	<b>34</b>	<b>28</b>	<b>-</b>	<b>18.7</b>

Deposit	Ore Reserve Category <sup>(3)</sup>	Ore Tonnes mt	In Situ HM Tonnes kt	HM Grade (%)	Clay Grade (%)	HM Assemblage <sup>(2)</sup>			
						Ilmenite Grade (%)	Zircon Grade (%)	Rutile Grade (%)	M+X Grade (%)
MSP By-Product Stockpile	Proved	0.69	0.58	84.7	3	32	27	-	21.6
	Probable	0.28	0.23	82.5	3	37	31	-	12.9
<b>Total<sup>(4)</sup></b>		<b>0.96</b>	<b>0.81</b>	<b>84.1</b>	<b>3</b>	<b>34</b>	<b>28</b>	<b>-</b>	<b>19.2</b>

Source: *Eneabba Mineral Sands Recovery Project Update*, 24 July 2019, available at [www.iluka.com/investors-media/asx-disclosures](http://www.iluka.com/investors-media/asx-disclosures). Updates to the Mineral Resource estimates for MSP By-products Stockpile were reported in Iluka's 2019 Annual Report, released 20 February 2020, Iluka's 2020 Annual Report, released 25 February 2021, Iluka's 2021 Annual Report, released 24 February 2022 and Iluka's 2022 Annual Report, released 21 February 2023, available at [www.iluka.com/investors-media/asx-disclosures](http://www.iluka.com/investors-media/asx-disclosures).

1. Mineral resources are inclusive of Ore Reserves
2. Mineral assemblage is reported as a percentage of in situ HM component.
3. Ore Reserves are a sub-set of Mineral Resources.
4. Rounding may generate differences in the last decimal place. The aggregated totals may appear to reflect a greater degree of precision than individual deposits to maintain consistency in reporting.



ILUKA

## For more information contact

Luke Woodgate, Group Manager, Investor Relations and Corporate Affairs

[investor.relations@iluka.com](mailto:investor.relations@iluka.com)

